

MONSTER





Index

5	Just Fun!	38	Servicing and maintenance
7	Design Monster	41	Technical data and equipment
15	All you need to have fun	53	Customization kits. More unique than ever
16	Chassis	58	Accessories Configure the Ducati of your dreams
20	Cutting-edge technology	60	Monster, as you like it
24	Mad For Fun	68	Monster, as you wear it
29	At the top of the segment	80	Ducati Digital Experience
31	Simplicity and fun. In one word: Monster		
33	Never again without it		
34	Dream. Feel. Thrill		
36	Rookie Academy Level Up your Ride		



Just Fun!

Climb aboard. Turn on the engine. Open the throttle and forget everything else. Become what you've always wanted to be. Experience something you previously only imagined. No frills, no formality. Just sheer fun. This is a bike that gets straight to the point. This is the naked you've been waiting for, because it fits like a second skin.

The Monster range grows with the SP version, designed to enhance fun, thanks to technical equipment perfect for those who love sporty riding and with a style embellished by the Desmosedici GP-inspired livery.

The photographs published in this catalogue portray professional riders in controlled road riding conditions. Do not imitate such riding behaviour, which may pose a danger to yourself or other road users.

The photos in this brochure are representative of the European version of the bike, which may differ in different countries depending on local regulations.



Monster design

The iconic, timeless style of the Monster enters a new era with a contemporary, cutting-edge design. All the distinctive elements are there, such as the engine, the undisputed scene-stealer, topped with the classic "bison-back" tank, the circular headlamp built into the 'shoulders', and the clean, streamlined tail section. But all with a more modern, sporty, and technological twist, designed to enhance the bike's personality and maximise rider enjoyment.

The tank is the visual centre of attention. The muscular Monster bison-back, complete with its deep sculpted hollows for the knees, boasts bulkier 'shoulders' that now extend towards the front wheel and loom over the dynamic turn signals, integrated into the two lateral wings*. Its proportions are also revised, now more compact to support ergonomics that prioritise comfort and efficiency.



MONSTER
DUCATI





The short tail, sleek yet sinuous and sculpted, comprises a visible rear subframe in glass fibre reinforced polymer, which serves both a structural and an aesthetic function, and two polished side panels.

The full LED headlamp retains the iconic spherical shape of the Monster but is modernised with the bright signature of the DRL daytime running lamp*. The structure of the headlamp is also updated with a transparent dome that fully integrates both the optic and electronic elements. Technical elements such as the fully visible central module and heat sink blend the modern and the technological.

In its new colour combination, the pure white and bright red selected for the seat upholstery highlight the simple, clean lines of the Monster. The red tags on the wheels add a sophisticated, sporty touch.

*Please check with your dealer feature availability.





The sporty nature of the new Monster SP is reinforced by the livery which incorporates the 2022 colors of the factory team's Desmosedici GP. The Ducati lettering on the tank is reminiscent of the graphics on the Panigale V4. The red-colored seat complements the side view of the tail with the Monster SP logo and the Italian flag on the passenger seat cover.





ENGINE

All you need to have fun

Cutting-edge performance and unrivalled riding pleasure. The latest evolution of Testastretta 11° twin makes the Monster your ideal partner.

With many of its components redesigned to reduce weight while maintaining performance and reliability, the 937 cc Testastretta 11° is smooth and controlled at low rpm, for a prompt response in city traffic, but also dynamic at medium-high rpm for electrifying performance at all times.

It is equipped with the Quickshifter Up/Down to ensure fast and precise shifting, both up and down the gears, without the use of the clutch. The advanced engine guarantees disarmingly simple excitement and fun.

With 937 cc, maximum power of 111 HP (82 kW) at 9250 rpm and maximum torque of 9.5 kgm (93 Nm, 69 lb ft) at 6500 rpm, the Testastretta 11° combines ultimate power and sportiness with an extremely precise and very manageable ride. The engine is Euro 5* compliant while respecting the family feeling. The L-shaped layout, liquid cooling, Desmodromic valve actuation system and characteristic sound quality are all unmistakable traits of a Ducati engine, also available in a 35kW restricted version.

* Only for countries where Euro 5 standard applies.

CHASSIS

A dry weight of 166 kg (366 lb), or rather 18 kg (40 lb) less than the Monster 821. An extraordinary saving made possible thanks to meticulous work to drop weight across every single component for an agile and manageable bike.

But as well as being incredibly light, the Monster is also extremely compact, with a wheelbase that is reduced to 1,474 mm (58.0 in).

1- Front Frame

The engine is load-bearing, connected to a Front Frame that is similar in concept to that of the Panigale V4. Created in aluminium, it is 4.5 kg (10 lb) lighter than the trellis frame of the Monster 821, for a 60% reduction in weight that contributes to the bike's overall lightness.

2- Sub-frame

The rear sub-frame – created in GFRP (Glass Fibre Reinforced Polymer) – is 1.9 kg (4 lb) lighter and adds to the clean, sports design of the Monster.

The chassis of the Monster is extremely functional and efficient. With solutions designed to offer easy, intuitive riding, the Monster inspires confidence in all conditions and is always able to elevate your abilities as a rider, whatever your level.

**3- Seat height**

The seat is positioned 820 mm (32.3 in) from the ground. This, combined with the bike's narrow sides, a result of the Front Frame, ensure that the rider can easily touch the ground with their feet. A lower 800 mm (31.5 in) saddle that still incorporates comfortable padding is available as an accessory. And for those who want it, a simple suspension kit that lowers the vehicle is also available, allowing the rider to further reduce the seat height to 775 mm (30.5 in).

4- Hydraulic clutch

The slipper clutch that equips the Monster works in an oil bath and is extremely soft to use thanks to a specific assist system. With a hydraulic control, it is extremely 'light' to activate (20% less effort on the lever with respect to the Monster 821) to satisfy riders of all experience levels. The gearbox has been redesigned to improve shifting precision. Mounted as standard, the Quick Shifter is the perfect companion during sports riding thanks to the support it provides when up- and down-shifting, but it is also a cure-all when riding city streets, as the rider need only use the clutch when making a standing start.

The conical aluminium handlebar and radial brake and clutch pumps are quality components that round out the high-level equipment on the Monster. And for more intense sports feeling, riders can make use of the Ducati Performance exhaust kit by Termignoni, available with a homologated slip-on silencer or as a full racing version.

1- Braking system

In developing the Monster braking system together with Brembo, the goal was to offer the best possible braking performance, while retaining excellent modulation and light, accurate activation. A system in which M4-32 monobloc radial callipers act on a pair of 320 mm front discs.



2- Tyres and wheels

Even the wheels, 1.7 kg (4 lb) lighter, contribute to the overall weight saving of the Monster. Created in lightweight alloy, they measure 3.5" x 17" and 5.5" x 17" and mount Pirelli Diablo Rosso III tyres in size 120/70 at the front and 180/55 at the rear. Perfectly suited to the sports nature of the Monster in both wet and dry conditions, the tyres offer maximum grip when leaning over.

3- Steering angle

The frame, as well as the careful positioning of elements like the radiator, has allowed for one big improvement with respect to the previous generation of Monster. Specifically, the steering angle is now raised to 36°, a good 7° increase. The Monster has never been so agile in traffic or through the bends, and is also easy and intuitive when changing direction.

4- Engine

The Monster mounts the 937 cc Testastretta 11° L twin engine complete with Desmodromic timing and Euro 5 homologation*. It weighs 2.6 kg (6 lb) less than the 821 cc engine despite its increased size, thanks to its many redesigned components.

* Only for countries where Euro 5 standard applies.

ELECTRONICS

Cutting-edge technology

Power Modes on the Monster are equipped with Smart functionality. In the lowest gears, dedicated torque curves that differ for each Power Mode reduce the level and frequency of control system intervention, for more manageable and intuitive bike usage.

There are three Smart Power Modes: High Power Mode (associated with Sport Riding Mode): a dedicated torque curve in 1st gear and a full torque curve in the remaining gears.

Medium Power Mode (Touring): dedicated torque curves in 1st and 2nd gears and a full torque curve in the remaining gears.

Low Power Mode (Urban): dedicated torque curves in 1st and 2nd gears and a limited torque curve (max. power 75 HP) in the remaining gears.

You can select the strategy you want based on the road conditions and personal preference at any time, even on the move, thanks to controls on the handlebar and indications on the dash. You can also customise each Riding Mode, modifying the default traction control, wheelie control and Cornering ABS intervention values, to create your very own Monster, tailor made to suit your riding style.



Every moment aboard the Monster will see the rider express their full potential, thanks also to the complete electronics package that fully supports the rider, combining sports performance with a high level of active safety.

Cornering ABS, adjustable according to three levels, comes as standard and ensures responsive braking in maximum safety, even when the bike is at an angle. More expert riders can make use of the ABS front-only mode, which deactivates ABS at the rear wheel for sports riding.

Even the acceleration phase is worry-free thanks to Ducati Traction Control (DTC) and Ducati Wheelie Control (DWC) – both in a Cornering version – which intervene electronically to limit rear wheel slide and front wheel lift.

With Ducati Power Launch, present for the first time on the Monster, you can be sure to make a spectacular getaway. Offering three levels, the system regulates torque delivery so that all you need do is release the clutch.



The full LED headlamp, with its modern lines and technological look, is equipped with the daytime running light system* that guarantees excellent visibility, near and far.

The LED turn signals ensure a rider remains visible and heighten safety with their auto-off function, which prevents them blinking for too long if left on. The rear light is also LED, so that the rider is always easily identifiable, even at a distance and in full daylight.

*Please check with your dealer for availability.

Whatever your path or reason for riding, you will always have everything under control thanks to the 4.3" high-res TFT display. Equipped with an extremely intuitive, complete, and easy to use HMI (Human Machine Interface), it adopts graphics inspired by those of the Panigale V4, sporty and easy on the eye.

And to expand your connectivity experience, the dash is set up for the Ducati Multimedia System, which allows a smartphone to be connected to the bike with a Bluetooth module, available as an accessory, so as to be able to manage functions such as music and calls via the handlebar controls.



Mad for Fun

The Monster SP takes the 2022 colors of the official team's Desmosedici GP, mounts Öhlins suspension and Termignoni homologated silencer, Brembo Stylema® calipers and Pirelli Diablo Rosso IV tires.

The sporting potential of the Monster SP is further enhanced by the steering damper, which improves stability under acceleration and cornering, while the general lightening of the bike also comes with the adoption of a lithium-ion battery, which brings the overall running order weight saving to about 2 kg compared to the standard model.

True sporty equipment that will make you fall in love with the new Monster SP, available also in depowered version. Are you ready for more?

Dedicated Sports Equipment

The golden Öhlins NIX30 fork enhances the sporty look of the new Monster SP. Together with Termignoni's homologated silencer and Brembo Stylema® front calipers, they make up the valuable technical equipment capable of making the bike even lighter, more effective and fun in sporty riding, as well as more aesthetically appealing.



Performance and fun with the Testastretta 11° engine

The heart of the Monster is the Testastretta 11° engine, a liquid-cooled 4-valve twin with 111 hp and desmodromic distribution.

Suspension

The fully adjustable Öhlins suspension, with the fork 0.6 kg lighter than that adopted on Monster and Monster +, increases the feel, as well as increasing ground clearance and consequently the lean angle.

Braking system

The upgrading of the braking system with Brembo Stylema® calipers and aluminium flanges for the 320 mm front brake discs (0.5 kg lighter than the Monster equipment) makes the Monster SP more performing when braking, but, at the same time, more agile thanks to the reduction of inertia at the front.

Lithium-ion battery

The general lightening of the bike also comes with the adoption of a lithium-ion battery, which brings the overall weight saving to about 2 kg in running order compared to the standard model, already a benchmark in the category for lightness, despite the addition of components such as the steering damper and the windshield.

Steering damper

The sporting potential of the Monster SP is further enhanced by the steering damper, which improves stability under acceleration and cornering.





MONSTER SP ELECTRONICS

At the top of the segment

Standard equipment includes ABS Cornering, Ducati Traction Control, Ducati Wheelie Control, all adjustable to different levels of intervention. The sporty character of the new Monster is also emphasized by Launch Control, which ensures lightning-fast starts. This top-of-the-line motorcycle equipment allows the Monster to safely express its performance.

Sport, Road and Wet Riding Modes allow you to mold the character of the Monster according to your tastes and needs. Everything is easily managed through the handlebar controls and the 4.3-inch color TFT dashboard.





Simplicity and fun. In one word: Monster.

Easy, intuitive, sporty and fully customisable. The Monster is ready to offer maximum enjoyment to anyone who rides it.

Lightweight and compact, it knows exactly how to accommodate any rider, even during low-speed manoeuvres.

The riding position, not overly loaded at the front, inspires confidence and safety, offers maximum comfort and zero stress, and is fun and efficient even during sports use.

The seat position is comfortable and secure, thanks to a saddle height of 820 mm (32.3 in), which can be reduced to 800 mm (31.5 in) with a dedicated low saddle available as an accessory, or even 775 mm (30.5 in) with the lowered suspension kit.

The brake and clutch levers are adjustable to allow every rider to alter lever position to suit their hand.

The hydraulic slipper clutch operates in an oil bath and is incredibly soft and easy to activate, particularly in the city, thanks to its unique assist system.

The Quick Shift up & down ensures smooth shifting and easy, precise gear insertion, doing away with the need for the clutch. The result? More enjoyable sports riding and less effort in an urban setting.

With the Sport, Touring and Urban Power Modes, riders can modify bike behaviour depending on the road conditions and their riding preferences, even while on the move. The Smart functionality means dedicated torque curves in the lowest gears limit traction control intervention for an even more intuitive riding experience.

The reduced steering diameter that results from the boosted steering angle (36°) allows the Monster to turn even in a restricted space, simplifying life in the city and in any situation where there is little space to manoeuvre.



Never again without it

Precise through the turns. Stable along the straight. Completely at ease whether in city traffic or on track. The Monster will trace your every movement, thanks to an advanced yet intuitive chassis that ensures a fun and fulfilling ride.

Created for your enjoyment

Experience the pleasure of a controlled ride. Unleash the power and fluidity of the 937 cc Testastretta 11° engine. Thanks to a sophisticated chassis and electronic equipment at the service of the rider, putting yourself to the test has never been such fun.

Dream. Feel. Thrill

The Ducati Monster is sheer riding pleasure and absolute control. It is the sports naked for everyone, from the inexperienced rider starting out on their two-wheel journey, to the expert who wants to have fun with a quick and agile bike, on and off the track.



The Monster grows in terms of its engine size, power and torque but loses weight to ensure agility, performance, and riding ease in every situation. **The Monster has a dry weight of just 166 kg** and mounts an engine that boasts maximum power of 111 HP (82 kW) and maximum torque of 9.5 kgm (93 Nm, 69 lb ft).

All the fun, performance and technology of the Monster and Monster SP are also available as a 35kW restricted-power version for those with an A2 licence. Contact your dealer to check availability.

DRE ROOKIE

Rookie Academy: Level Up your Ride

DRE Rookie is the DRE Academy course dedicated to young riders, from 18 to 24 years of age, who possess an A2 licence and ride restricted bikes. The professional team of instructors will teach participants all the tricks they need to acquire and develop the right techniques and improve their riding, safely and enjoyably.

DRE Rookie stems from a Ducati project dedicated to riding safety and highlights the company's commitment to promoting the concept of safe and responsible riding.

Your development starts here: climb aboard, boost your riding ability, and unleash your potential as a rider!



Servicing and maintenance

Safety as standard

The constant work that Ducati carries out in terms of design, research and development has the precise aim of ensuring increasing cutting-edge bikes that are characterised by maximum levels of active safety. A commitment that involves the definition of increasingly advanced systems to increase the rider's level of control, such as Cornering ABS, traction control and wheelie control. Equipment that optimises bike behaviour in both braking and acceleration and that offers numerous possibilities for adjustment with different intervention levels for the ABS, traction control and wheelie control, which the rider can select.

More value to your passion

With Ever Red, the quality and reliability of the Ducati brand will be your enduring travel companions. Ever Red is the exclusive Ducati warranty extension programme. In activating it, you will continue to be fully protected for 12 or 24 months beyond the standard Ducati Warranty period (24 months). Ever Red includes roadside assistance for the entire period of coverage and does away with mileage limits. This means you can travel as far as you wish, even overseas, enjoying your Ducati with complete peace of mind.

To find out whether the Ever Red extension is available in your country and for further details, refer to your Ducati dealer or visit ducati.com.

Endless excitement

In designing each bike, Ducati constantly strives to ensure maximum reliability while reducing service costs. A commitment that has seen the intervals for the main Desmo Service, in which valve clearance is checked and adjusted if necessary, to be extended to 30,000 km (18,000 mi) for the Monster.

Even the simplest of checks, such as the Oil Service, are extended to 15,000 km (9,000 mi) or 12 months. A considerable interval for such high-performance engines, which only confirms the significant quality standards applied to material selection and R&D processes.

Ducati continuously invests in the technical training of its dealers. The specific skills offered by the official Ducati Service network ensure that all those operations needed to keep every Ducati in perfect condition are meticulously executed, while advanced equipment such as the Ducati Diagnosis System allows the software on each Ducati to be updated with the latest releases, ensuring that the electronics continue to perform at the maximum level.

Always by your side

One of Ducati's main goals is to offer every Ducatista the chance to enjoy unlimited and safe travel all over the world. To achieve this aim, Ducati offers a "fast delivery" original spares service, with delivery in 24/48 hours across 85% of the areas in which it operates. With a distribution network that covers more than 96 countries, thanks to 821 (760 Sales & Service, 61 Service) official Dealers and Service Points*, choosing a Ducati means you can travel worry free and in total freedom, wherever the road may take you, and count on support from our extensive Dealer network that ensures Ducati quality and professionalism is always close at hand.

821 Authorised dealers and service points

96 World countries

*Information updated on 31/12/2022



Ever Red
Extended Warranty



*Equal to 18,000 miles.





Technical data and equipment

Dimensions

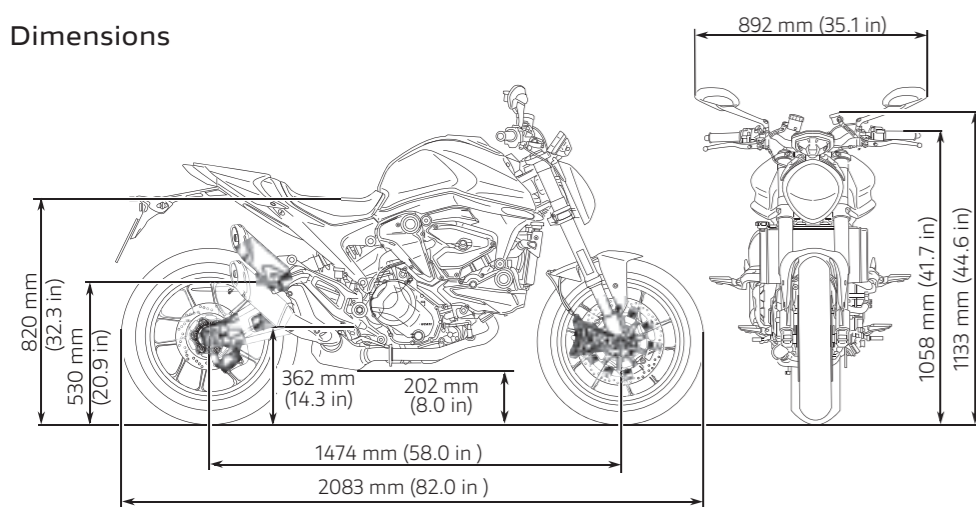

Power and torque

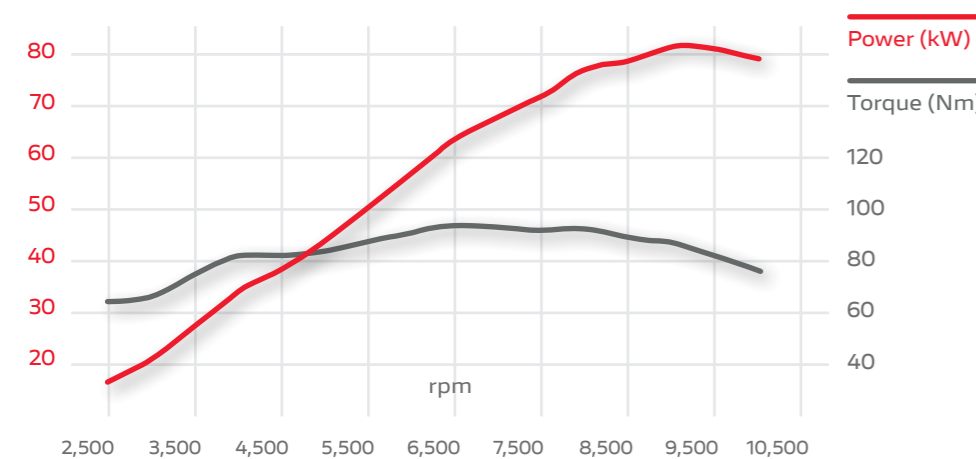

Engine

Engine Testatretta 11°, V2 - 90°, 4 valves per cylinder, desmodromic valvetrain, liquid cooled

Displacement 937 cc (57 cu in)

Bore X stroke 94 mm x 67.5 mm

Compression ratio 13.3:1

Power 111 hp (82 kW) @ 9,250 rpm

Torque 9.5 kgm (93 Nm, 69 lb ft) @ 6,500 rpm

Fuel injection Electronic fuel injection system, Ø 53 mm throttle bodies with Ride-by-Wire system

Exhaust Pre-muffler and twin muffler, catalytic converter and 2 lambda probes

Transmission

Gearbox 6 speed

Primary drive Straight cut gears, ratio 1.85:1

Ratio 1=37/15, 2=30/17, 3=28/20, 4=26/22, 5=24/23, 6=23/24

Final drive Chain, front sprocket z15, rear sprocket z43

Clutch Slipper and self-servo multiplate wet clutch with hydraulic control

Chassis

Frame Aluminum alloy Front Frame

Front suspension Ø 43 mm usd fork

Front wheel Light alloy cast, 3.5" x 17"

Front tyre Pirelli Diablo Rosso III 120/70 ZR17

Rear Suspension Progressive linkage, preload adjustable monoshock, aluminium double-sided swingarm

Rear Wheel Light alloy cast, 5.5" x 17"

Rear tyre Pirelli Diablo Rosso III 180/55 ZR17

Wheel travel (front/rear) 130 mm / 140 mm (5.1 in / 5.5 in)

Front brake 2 x Ø 320 mm semi-floating discs, radially mounted Brembo M4.32 monobloc 4-piston callipers, radial master cylinder, Cornering ABS

Rear brake Ø 245 mm disc, Brembo 2-piston floating calliper, Cornering ABS

Instrumentation 4.3" TFT colour display

Dimensions and weights

Wet weight no fuel 179 kg (395 lb)

Seat height

820 mm (32.3 in)
800 mm (31.5 in) (accessory low seat)
775 mm (30.5 in) (accessory low seat + low suspension kit)

Wheelbase 1,474 mm (58.0 in)

Rake 24°

Front wheel trail 93 mm (3.7 in)

Fuel tank capacity 14 l (3.7 US gal)

Number of seats 2

Safety equipment

Riding Modes, Power Modes, Cornering ABS, Ducati Traction Control, Ducati Wheelie Control, Daytime Running Light**

Standard equipment

Ducati Quick Shift, Ducati Power Launch, 4.3" TFT colour display, Full LED headlight and lighting system, Dynamic turn indicators**, USB power socket, Flyscreen (Plus version), Passenger seat cover (Plus version)

Ready for

Ducati Multimedia System, Heated grips

Warranty and

Warranty 24 months, unlimited mileage

Oil change 15,000 km (9,000 miles) / 24 months

Valve clearance check 30,000 km (18,000 miles)

Emission & Consumptions (only for countries where Euro 5 standard applies)

Standard Euro 5

Emission CO₂ 120 g/km

Consumptions 5.2 l/100 km



*Equal to 18,000 miles

Indication of mileage at the first Desmo Service, or rather the first service during which valve clearance is checked and adjusted if necessary.

The Monster is also available for holders of limited driving license in a version with reduced power to 35 kW. Contact your dealer to check availability.

** Please check with your dealer feature availability.

Ducati Red
with black wheels



Aviator Grey
with GP Red wheels



Iceberg White
with black wheels



Ducati Red
with black wheels



Aviator Grey
with GP Red wheels



Iceberg White
with black wheels



MONSTER SP

SP livery



	Monster and Monster+	Monster SP
Front suspension	Ø 43 mm usd fork	Fully adjustable Öhlins NIX 30 Ø 43 mm usd front fork with TiN treatment on inner tube
Rear Suspension	Progressive linkage, preload adjustable monoshock, aluminium double-sided swingarm	Progressive linkage, fully adjustable Öhlins monoshock, aluminium double-sided swingarm
Wheel travel (front/rear)	130 mm / 140 mm (5.1 in / 5.5 in)	140 mm / 150 mm (5.5 in / 5.9 in)
Tyre	Pirelli Diablo Rosso III	Pirelli Diablo Rosso IV
Seat height	820 mm (32.3 in) 800 mm (31.5 in) (low seat accessory) 775 mm (30.5 in) (low seat accessory + low suspension kit)	840 mm (33.1 in) 850 mm (33.5 in) (high seat accessory) 810 mm (31.9 in) (low seat accessory)
Steering damper	○	●
Termignoni silencer	○	●
Lithium-ion battery	Unavailable	●
Front brake calipers	Brembo M4.32	Brembo Stylema®
Aluminium disc flanges	Unavailable	●

● Standard ○ Accessory



1 Lithium-ion battery

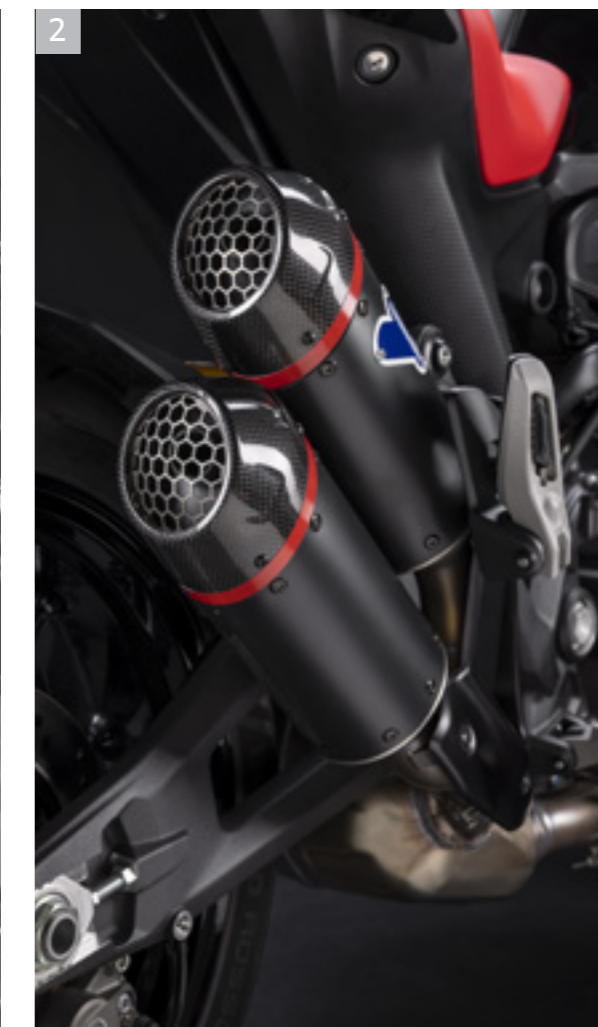

2 Pre-muffler and Termignoni type approved twin muffler, catalytic converter and 2 lambda probes



3 Radially mounted Brembo Stylema® monobloc 4-piston callipers



Customization kits. More unique than ever

Monster has always been synonymous with personality. And the new Monster makes it even easier for the rider to express this with new customisation kits, comprising decals (decal kit) or painted plastic parts (cover kit). Simply choose from among the many combinations available. Have fun making your new Monster more unique than ever!



Pixel cover kit

A bold, sporty and modern look: the choice for those who don't like to go unnoticed. The kit consists of tank cover, seat side body panels, seat cover, headlight fairing and front mudguard, and is compatible with all models. An accessory to characterise and personalise the bike to the maximum, giving the Monster an even more aggressive, unmistakable look.



Try the online configurator and customise your new Ducati bike at configurator.ducati.com



GP cover kit

Sophisticated yet sporty graphics to bring out the style and allure of your bike. Similar to the design used on GP motorcycles, the kit is available in the tones of the three electrifying colour schemes of the range and consists of tank covers and seat side body panels.



Try the online configurator and customise your new Ducati bike at configurator.ducati.com

ACCESSORIES

Configure the Ducati of your dreams.

The new Monster represents all the essence of Ducati in the lightest, most compact and essential form possible. You can already guess it from the name: Monster, nothing else.

Configure.

Choose the ideal Panigale V4 for you and have fun configuring it to suit your riding style! Share it with friends and send it to your Ducati dealer who will contact you for an online consultation to discuss the current offers that best suit your needs.

Save your configuration to return to it at any time.

Calculate your payment

Ducati Financial Services offers favourable solutions for the financing of every model in the Ducati range. Personalise your financing and calculate the monthly instalments. You can then contact your dealer and discuss the best way to see your dream come true!



Go to configurator

For more information about the Ducati Performance range, tech specs and instructions, refer to a Ducati dealer or visit the Accessories section of ducati.com

ACCESSORIES

Monster, as you like it

The Monster strength lies in its diversity. In addition to the customisation kits, which can help define the look of your Monster, you can also make use of a wide range of accessories to adapt the Monster to your needs and personality. Push your performance to the max with Ducati Performance accessories. Perfect your style with refined details and quality finishes. The Monster is as unique as you are.



Try the online configurator and customise your new Ducati bike at configurator.ducati.com



1. Silencers. OK EU5



2. Pixel customisation kit Aluminium rear-view mirrors OK A Licence plate holder kit OK A



3_ LH aluminium rear-view mirror. OK A 4_ Brake fluid reservoir. A

5_ Billet aluminium water pump cover. A

6_ Underseat aluminium number plate holder. OK 7_ Billet aluminium footpegs. OK



9_ Sport Headlight Fairing. ■ ■ ■ 10_ Billet aluminium handlebar balancing weights. A ■ ■



11_ Oil filler plug. ■ ■ 12_ Engine belly fairing. ■ ■ ■





13



14

13_ Brake lever protection. **A** 14_ "Tanklock®" flange kit.



15

15_Adhesive tank protector.



16

16_ Passenger grab handles.



17



18

17_ Tank bag with tanck-lock fastener.. 18_Engine tip.

APPAREL

Monster, as you wear it

Comfortable yet anything but ordinary. Elegant but also sporty. Much more than a simple clothing collection, Monster apparel is a statement of style and personality, to be flaunted on the road, on track and in everyday life.

Ducati Apparel Collection designed by *Drudi Performance*



Check out the Apparel collection dedicated to this bike

The configurator that allows you to customise your suit, in terms of graphics and on your specific physique, is available on www.ducatisumisura.com



77
T-shirt
Sketch 2.0
T-shirt



5

7









Ducati Digital Experience

A mission for every channel. Continuous updating on the innovation and passion for which our work stands out. We transform emotions into exclusive content. Just a click away.

Follow us on:

 www.ducati.com

 [@ducati](https://www.facebook.com/ducati)

 [@ducati](https://www.instagram.com/ducati)

 [Ducati Motor Holding](https://www.youtube.com/DucatiMotorHolding)

 [@DucatiMotor](https://twitter.com/DucatiMotor)

 [@ducati_official](https://www.tiktok.com/@ducati_official)

Ducati Motor Holding



MyDucati App

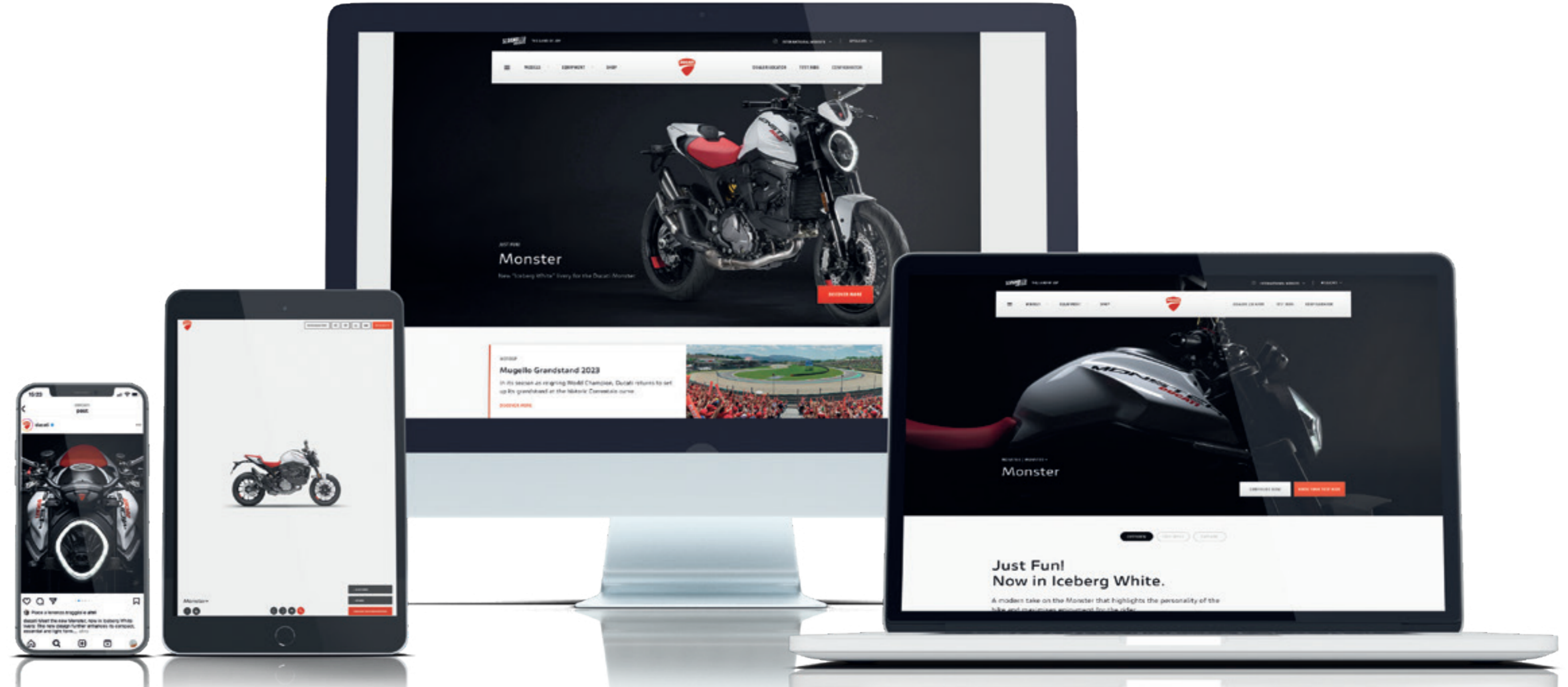



MyDucati is the personal area for every Ducatista, offering a wide range of services accessible with a single login from both the web and the app. Explore all the features of the MyDucati world and enjoy a multi-channel, customised experience wherever you are.





Key to symbols

-  This product is designed exclusively for race bikes ridden on a closed racetrack. Its use on public roads is forbidden by law.
-  This accessory is not approved for road circulation.
-  For racing use only. The product marked with this symbol can only be used on competition vehicles. Use outside a competition track of motorcycles equipped with this product is prohibited by law. Verify any further restrictions with the relevant race course. Motorcycles equipped with this accessory are prohibited from operating on public roads.

-  Anodized
-  Matt
-  Red
-  Black
-  Silver

Riding a motorcycle is the most exciting way to enjoy the road, and offering the utmost safety to the motorcyclist is Ducati's commitment. Ducati bikes are increasingly easy to handle, reliable and better equipped to guarantee maximum safety and enhance riding pleasure. Technical clothing is made with more and more advanced materials for adequate protection and increased visibility. The safety of motorcyclists is Ducati's commitment. For more information visit the safety section of the Ducati site (www.ducati.com).

WARNING: The photos and technical information in this catalogue may refer to prototypes subject to modifications during production and are purely for illustration and reference purposes, and are therefore not binding on Ducati Motor Holding S.p.A. Sole Shareholder Company - Company subject to the direction and coordination of AUDI AG ("Ducati"). Ducati cannot be held responsible for any print and/or translation errors. This catalogue is transnational and therefore some products may not be available and/or their features may vary in accordance with local laws. Not all colours and versions are available in each country. Ducati reserves the right to make changes and improvements to any product without obligation of prior notice or to make such changes to products already sold. Further characteristics of the products

are contained in the pertinent owner's manuals. The products represented are not definitive versions and are therefore subject to significant changes at Ducati's discretion without prior notice. The photographs published in this catalogue show only professional riders under controlled street conditions. Do not attempt to imitate such riding behaviour as it could be dangerous for you or other people on the road. This catalogue, including but not limited to the trademarks, logos, texts, images, graphics and table of contents herein, constitute Ducati intellectual property, or in any event Ducati has the right to reproduce it; any reproduction, modification or other whole or partial use of the catalogue or its contents, including publication on the Internet without the prior written consent of Ducati, is prohibited.

Actual fuel consumption may vary based on many factors, including but not limited to riding style, maintenance performed, weather conditions, surface characteristics, tyre pressure, load, weight of the rider and the passenger, accessories.

Ducati indicates the dry weight of the motorcycle excluding battery, lubricants and coolants for liquid-cooled models. The weights in running order are considered with all operating fluids, standard equipment and the fuel tank filled to 90% of its useful capacity (UE regulation no. 168/2013). For more information visit www.ducati.com.

February 2024



ducati.com

WDW2024
WORLD DUCATI WEEK
26th - 28th July / Misano, Italy
wdw.ducati.com

Developed with  Shopify

Technical partner 